

NewTrend Concepts

ITALIA

*You can sit on a real sofa
and sleep on a real bed*



NEW SYSTEM SOFABEDS 2019



CARRIE



A brand new definition of the SOFABED

New Trend Concepts Italia have redefined the sofabed by combining the support of pocket springs with the comfort of memory foam creating new seat to sleep hybrid technology which has been specifically designed for pure comfort.

*YOU CAN SIT ON A REAL SOFA AND
SLEEP ON A REAL BED*

The new one-touch, easy opening **ROLLER MECHANISM** allows the use of a deeper mattress than the traditional 3 fold systems on the market.

The new **POSTURAL PLUS** integrated mattress is designed to be twice as deep as the traditional systems, allowing it to handle more weight with added bonus for a longer sofa seat... that feels like a real bed!

TECHNIC DETAIL

SOFA BED

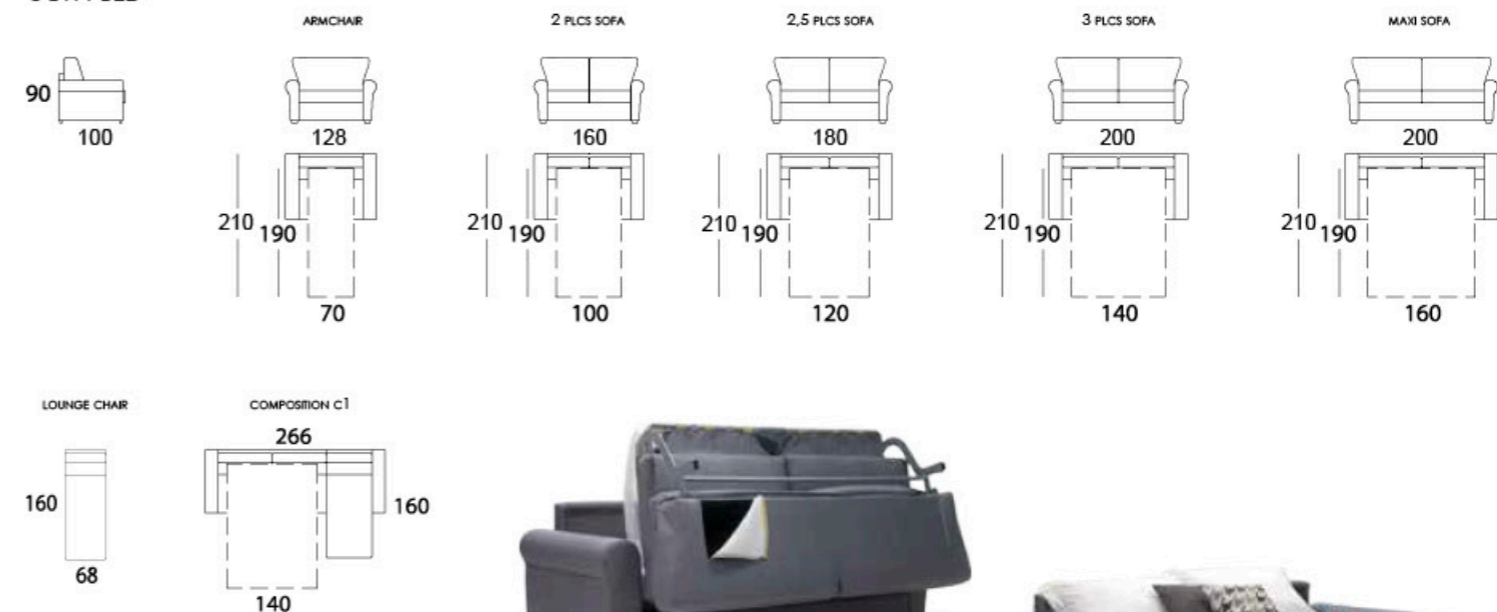

SOFA BED WITH METAL, RIGID, ELECTRO-WELDED GRID
 POLYURETHANE FOAM MATTRESS
 STORAGE COMPARTMENT FOR HEAD PILLOWS
 STRUCTURE: STRONG METALLIC STRUCTURE, WOODEN PARTICLE
 BOARDS WITH BAYONET JOINTS
 UPHOLSTERY: VARIOUS DENSITIES POLYURETANE FOAMS + ACRYLIC
 WADDING
 SEATS: COIL SPRINGS BOXED IN POLYURETHANE FOAM AND
 COVERED WITH POLYESTER WADDING
 BACKREST: DENSITY 30 KG / C.M.
 COVERS: PARTIALLY REMOVABLE FABRIC

NewTrendConcepts
 ITALIA

SELENE



ZAIRA



TECHNIC DETAIL

SOFA BED

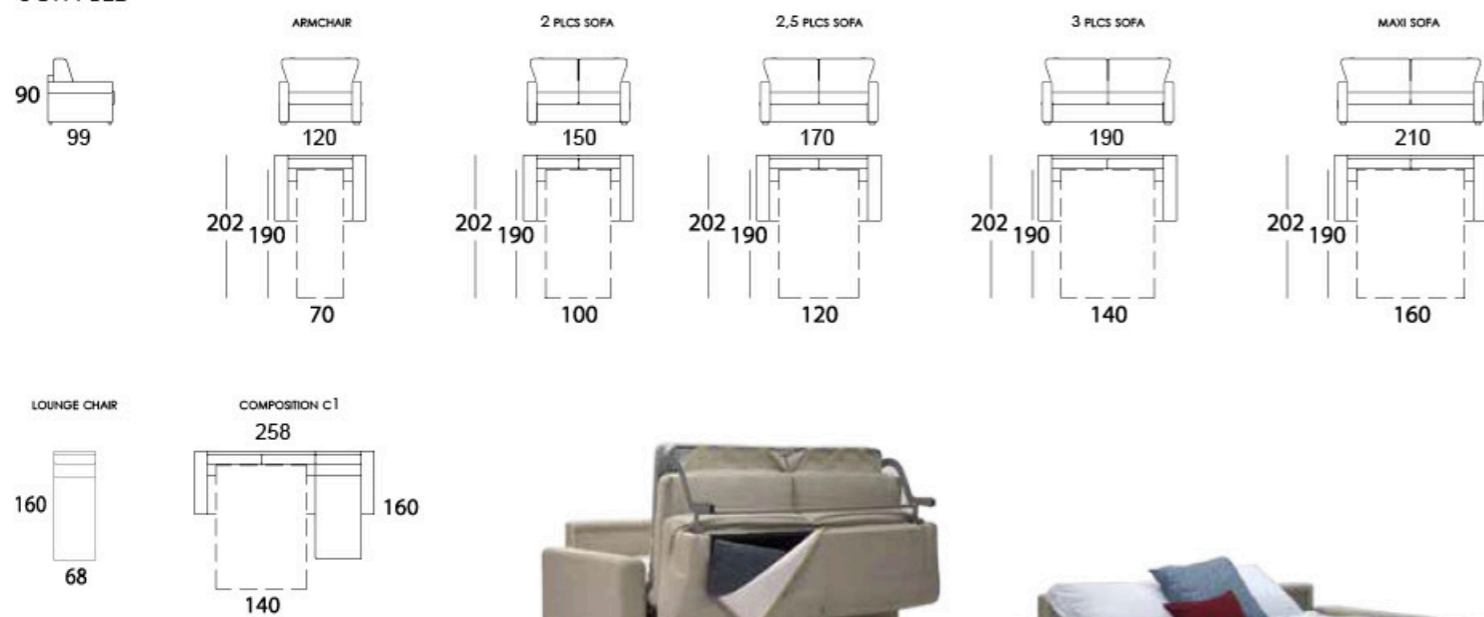

TECHNIC DETAIL

SOFA BED

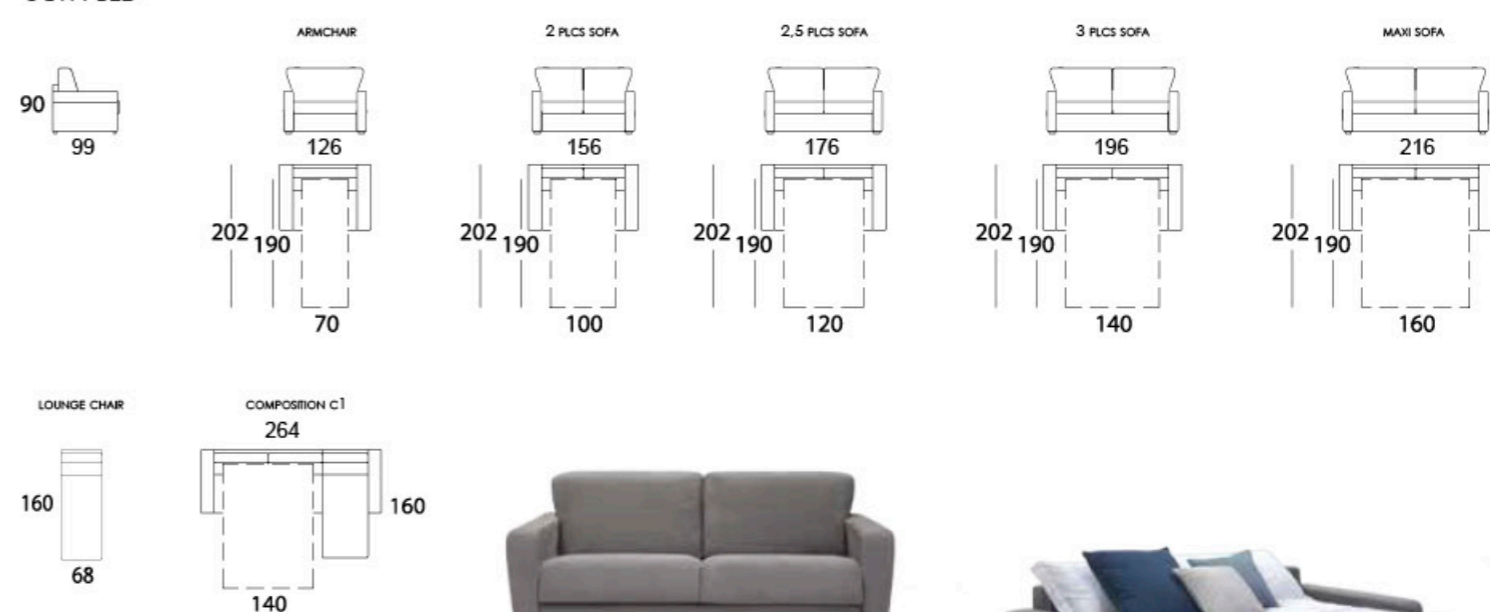

SOFABED WITH METAL, RIGID, ELECTRO-WELDED GRID
 POLYURETHANE FOAM MATTRESS
 STORAGE COMPARTMENT FOR HEAD PILLOWS
 STRUCTURE: STRONG METALLIC STRUCTURE, WOODEN PARTICLE
 BOARDS WITH BAYONET JOINTS
 UPHOLSTERY: VARIOUS DENSITIES POLYURETANE FOAMS + ACRYLIC
 WADDING
 SEATS: COIL SPRINGS BOXED IN POLYURETHANE FOAM AND
 COVERED WITH POLYESTER WADDING
 BACKREST: DENSITY 30 KG / C.M.
 COVERS: PARTIALLY REMOVABLE FABRIC

SOFABED WITH METAL, RIGID, ELECTRO-WELDED GRID
 POLYURETHANE FOAM MATTRESS
 STORAGE COMPARTMENT FOR HEAD PILLOWS
 STRUCTURE: STRONG METALLIC STRUCTURE, WOODEN PARTICLE
 BOARDS WITH BAYONET JOINTS
 UPHOLSTERY: VARIOUS DENSITIES POLYURETANE FOAMS + ACRYLIC
 WADDING
 SEATS: COIL SPRINGS BOXED IN POLYURETHANE FOAM AND
 COVERED WITH POLYESTER WADDING
 BACKREST: DENSITY 30 KG / C.M.
 COVERS: PARTIALLY REMOVABLE FABRIC

SORAYA



AIMEE



TECHNIC DETAIL

SOFA BED

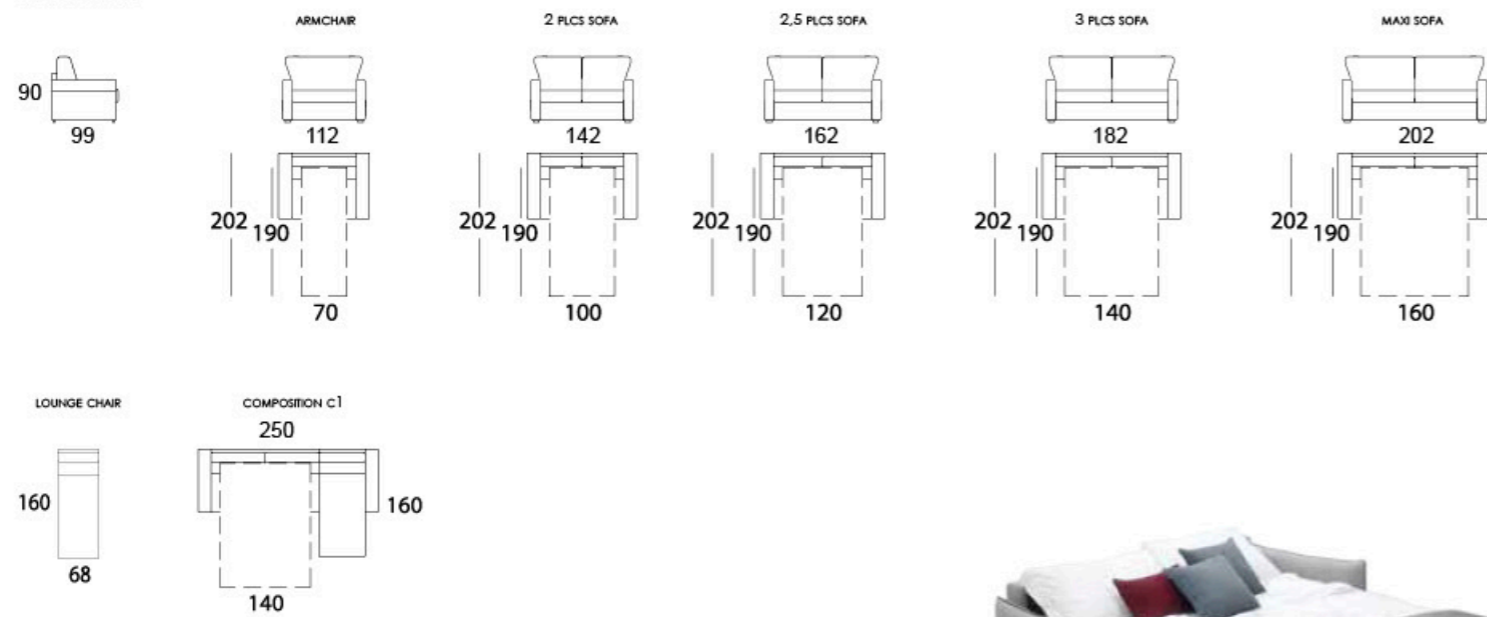

SOFABED WITH METAL, RIGID, ELECTRO-WELDED GRID
 POLYURETHANE FOAM MATTRESS
 STORAGE COMPARTMENT FOR HEAD PILLOWS
 STRUCTURE: STRONG METALLIC STRUCTURE, WOODEN PARTICLE
 BOARDS WITH BAYONET JOINTS
 UPHOLSTERY: VARIOUS DENSITIES POLYURETANE FOAMS + ACRYLIC
 WADDING
 SEATS: COIL SPRINGS BOXED IN POLYURETHANE FOAM AND
 COVERED WITH POLYESTER WADDING
 BACKREST: DENSITY 30 KG / C.M.
 COVERS: PARTIALLY REMOVABLE FABRIC



TECHNIC DETAIL

SOFA BED

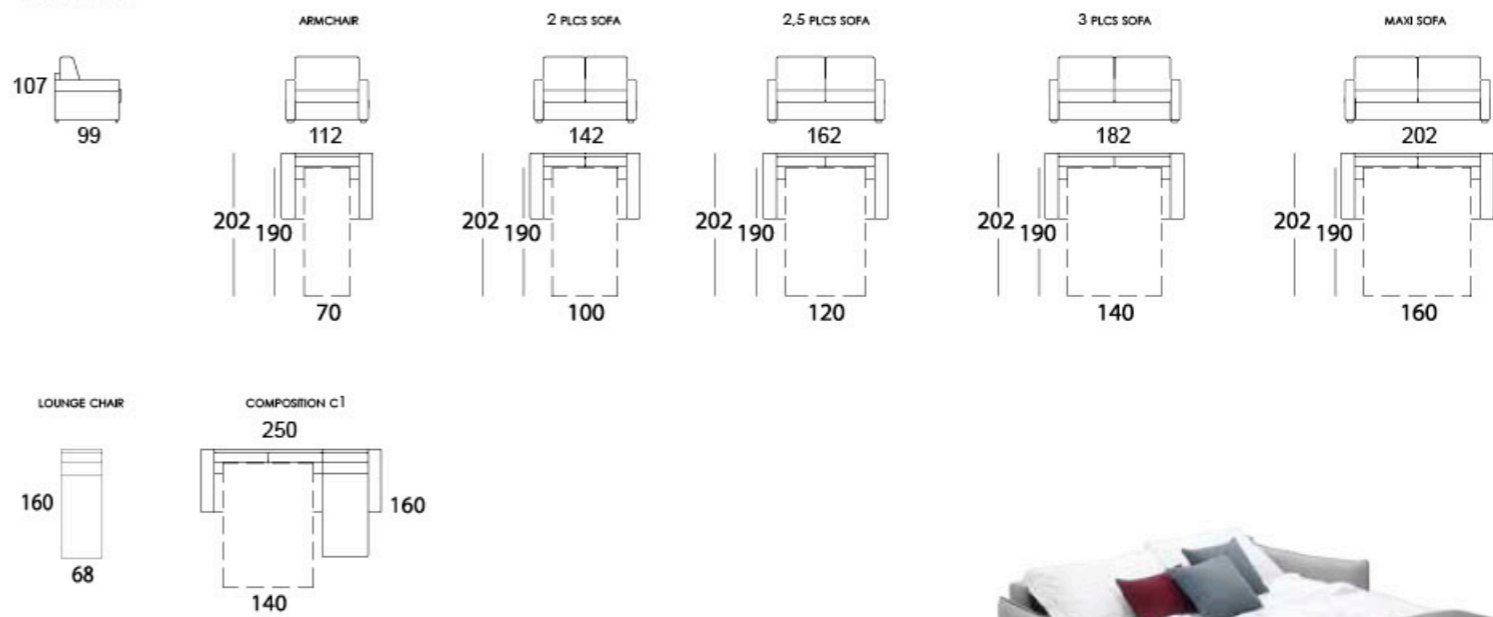

SOFABED WITH METAL, RIGID, ELECTRO-WELDED GRID
 POLYURETHANE FOAM MATTRESS
 SPECIAL ANATOMIC HIGH BACK
 STRUCTURE: STRONG METALLIC STRUCTURE, WOODEN PARTICLE
 BOARDS WITH BAYONET JOINTS
 UPHOLSTERY: VARIOUS DENSITIES POLYURETANE FOAMS + ACRYLIC
 WADDING
 SEATS: COIL SPRINGS BOXED IN POLYURETHANE FOAM AND
 COVERED WITH POLYESTER WADDING
 BACKREST: DENSITY 30 KG / C.M.
 COVERS: PARTIALLY REMOVABLE FABRIC



SUAMI



DALILA



TECHNIC DETAIL

SOFA BED

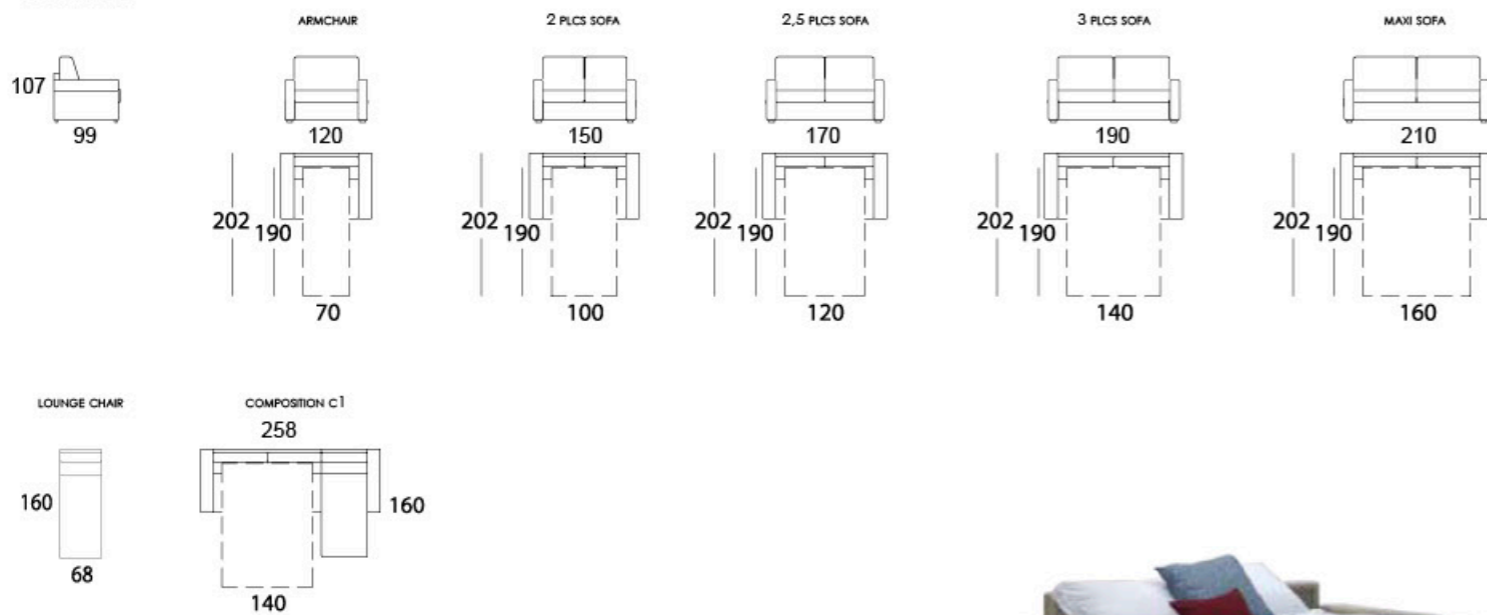

TECHNIC DETAIL

SOFA BED

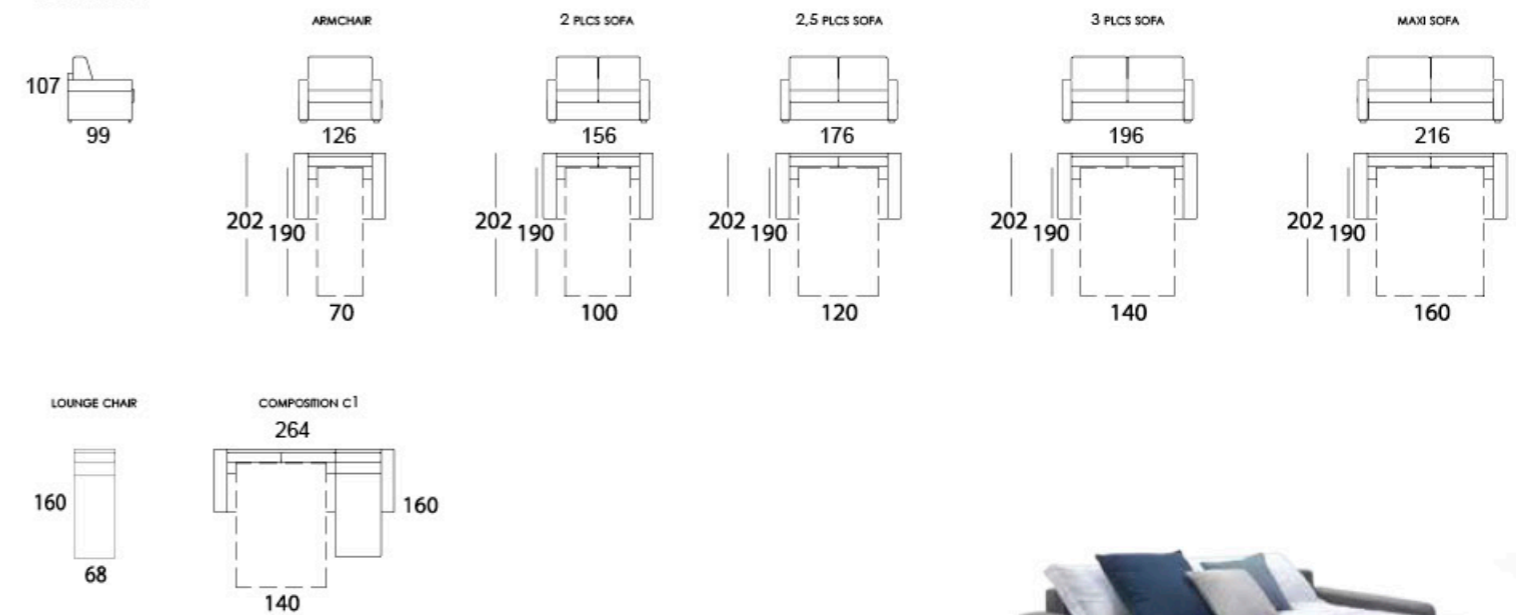

SOFABED WITH METAL, RIGID, ELECTRO-WELDED GRID
 POLYURETHANE FOAM MATTRESS
 SPECIAL ANATOMIC HIGH BACK
 STRUCTURE: STRONG METALLIC STRUCTURE, WOODEN PARTICLE
 BOARDS WITH BAYONET JOINTS
 UPHOLSTERY: VARIOUS DENSITIES POLYURETANE FOAMS + ACRYLIC
 WADDING
 SEATS: COIL SPRINGS BOXED IN POLYURETHANE FOAM AND
 COVERED WITH POLYESTER WADDING
 BACKREST: DENSITY 30 KG / C.M.
 COVERS: PARTIALLY REMOVABLE FABRIC



SOFABED WITH METAL, RIGID, ELECTRO-WELDED GRID
 POLYURETHANE FOAM MATTRESS
 SPECIAL ANATOMIC HIGH BACK
 STRUCTURE: STRONG METALLIC STRUCTURE, WOODEN PARTICLE
 BOARDS WITH BAYONET JOINTS
 UPHOLSTERY: VARIOUS DENSITIES POLYURETANE FOAMS + ACRYLIC
 WADDING
 SEATS: COIL SPRINGS BOXED IN POLYURETHANE FOAM AND
 COVERED WITH POLYESTER WADDING
 BACKREST: DENSITY 30 KG / C.M.
 COVERS: PARTIALLY REMOVABLE FABRIC



LEXI



BED MATTRESS H 12



COVER
(100% pes) stretch cover acrylic wadding
machine wash 30°

INTERIOR
Polyurethane foam
density 30 kg/m³

DENSITY
30 kg/m³ - H 12

BED MATTRESS H 16



COVER
(100% pes) stretch cover acrylic wadding
machine wash 30°

INTERIOR
Polyurethane foam
density 35 kg/m³

DENSITY
35 kg/m³ - H 16

TECHNIC DETAIL

SOFA BED

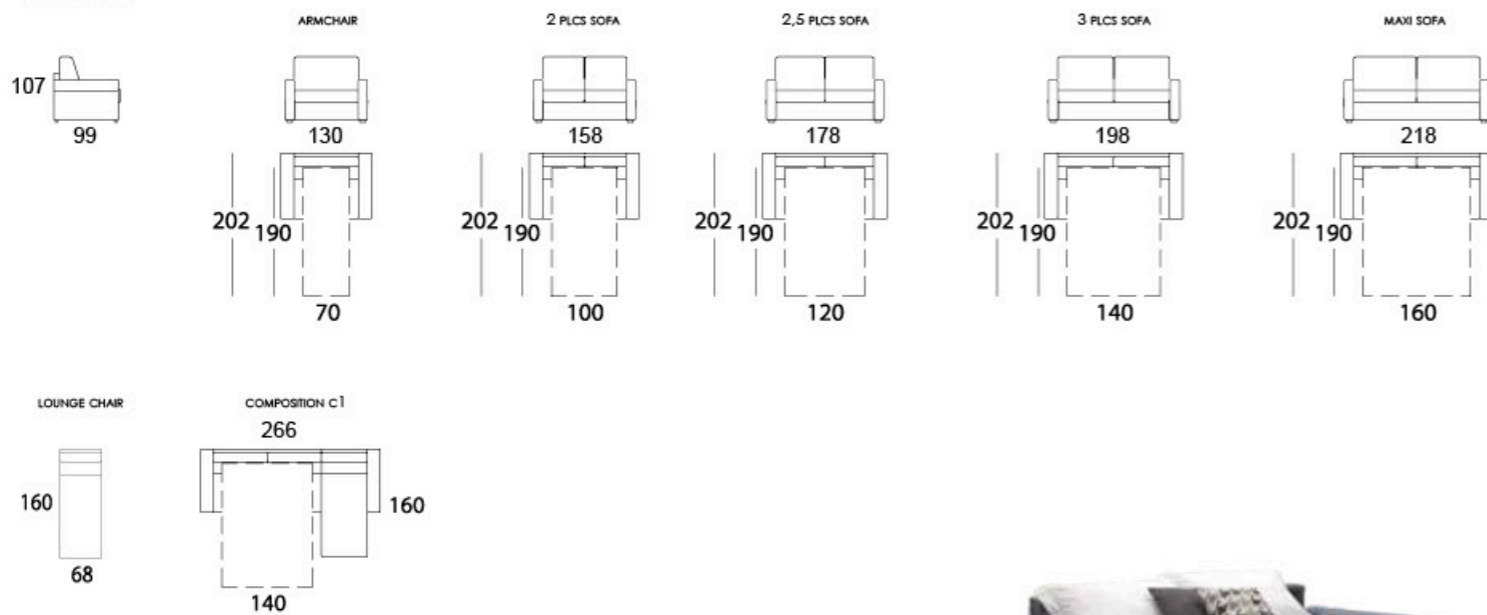

SOFABED WITH METAL, RIGID, ELECTRO-WELDED GRID
POLYURETHANE FOAM MATTRESS
SPECIAL ANATOMIC HIGH BACK
STRUCTURE: STRONG METALLIC STRUCTURE, WOODEN PARTICLE
BOARDS WITH BAYONET JOINTS
UPHOLSTERY: VARIOUS DENSITIES POLYURETANE FOAMS + ACRYLIC
WADDING
SEATS: COIL SPRINGS BOXED IN POLYURETHANE FOAM AND
COVERED WITH POLYESTER WADDING
BACKREST: DENSITY 30 KG / C.M.
COVERS: PARTIALLY REMOVABLE FABRIC

SELENE

H.90 P.100



VERSION BED H12	WIDTH	OFFER	A	B	MEASURES MATTRESS STANDARD ELECT/F.R. 30KG	MT. FABRIC
MAXI SOFA	212	559	574	589	160x190 H12	/
3 PLCS SOFA	192	529	544	559	140x190 H12	/
2,5 PLCS SOFA	172	524	539	534	120x190 H12	/
2 PLCS SOFA	152	519	534	549	100x190 H12	/
ARMCHAIR BED	122	514	529	544	70x190 H12	/
LOUNGE CHAIR (WITH CONTAINER)	68x160	389	399	409	/	/

Supplement Mattress

MATTRESS H 16 cm



MAXI SOFA	3 PLCS SOFA	2,5 PLCS SOFA	2 PLCS SOFA	ARMCHAIR
45	40	37	34	30

CARRIE

H.90 P.100



VERSION BED H12	WIDTH	OFFER	A	B	MEASURES MATTRESS STANDARD ELECT/F.R. 30KG	MT. FABRIC
MAXI SOFA	220	559	574	589	160x190 H12	/
3 PLCS SOFA	200	529	544	559	140x190 H12	/
2,5 PLCS SOFA	180	524	539	534	120x190 H12	/
2 PLCS SOFA	160	519	534	549	100x190 H12	/
ARMCHAIR BED	128	514	529	544	70x190 H12	/
LOUNGE CHAIR (WITH CONTAINER)	68x160	389	399	409	/	/

Supplement Mattress

MATTRESS H 16 cm



MAXI SOFA	3 PLCS SOFA	2,5 PLCS SOFA	2 PLCS SOFA	ARMCHAIR
45	40	37	34	30

ZAIRA

H.90 P.100



VERSION BED H12	WIDTH	OFFER	A	B	MEASURES MATTRESS STANDARD ELECT/F.R. 30KG	MT. FABRIC
MAXI SOFA	216	559	574	589	160x190 H12	/
3 PLCS SOFA	196	529	544	559	140x190 H12	/
2,5 PLCS SOFA	176	524	539	534	120x190 H12	/
2 PLCS SOFA	156	519	534	549	100x190 H12	/
ARMCHAIR BED	126	514	529	544	70x190 H12	/
LOUNGE CHAIR (WITH CONTAINER)	68x160	389	399	409	/	/

CUSHIONS

All CUSHIONS are made strictly in the same fabric and color of the sofa

FABRICS COORDINATES

For sofas and armchairs made of two different fabrics you must add an additional charge of 5%

SORAYA

H.90 P.100



VERSION BED H12	WIDTH	OFFER	A	B	MEASURES MATTRESS STANDARD ELECT/F.R. 30KG	MT. FABRIC
MAXI SOFA	202	559	574	589	160x190 H12	/
3 PLCS SOFA	182	529	544	559	140x190 H12	/
2,5 PLCS SOFA	162	524	539	534	120x190 H12	/
2 PLCS SOFA	142	519	534	549	100x190 H12	/
ARMCHAIR BED	112	514	529	544	70x190 H12	/
LOUNGE CHAIR (WITH CONTAINER)	68x160	389	399	409	/	/

*CUSHIONS

All CUSHIONS are made strictly in the same fabric and color of the sofa

FABRICS COORDINATES

For sofas and armchairs made of two different fabrics you must add an additional charge of 5%



VERSION BED H12	WIDTH	OFFER	A	B	MEASURES MATTRESS STANDARD ELECT/F.R. 30KG	MT. FABRIC
MAXI SOFA	202	634	649	664	180x190 H12	/
3 PLCS SOFA	182	599	614	629	140x190 H12	/
2,5 PLCS SOFA	162	594	609	624	120x190 H12	/
2 PLCS SOFA	142	589	604	619	100x190 H12	/
ARMCHAIR BED	112	584	599	614	70x190 H12	/
LOUNGE CHAIR (WITH CONTAINER)	68x160	424	434	444	/	/

Supplement Mattress

MATTRESS H 16 cm



MAXI SOFA	3 PLCS SOFA	2,5 PLCS SOFA	2 PLCS SOFA	ARMCHAIR
45	40	37	34	30



VERSION BED H12	WIDTH	OFFER	A	B	MEASURES MATTRESS STANDARD ELECT/F.R. 30KG	MT. FABRIC
MAXI SOFA	216	634	649	664	180x190 H12	/
3 PLCS SOFA	196	599	614	629	140x190 H12	/
2,5 PLCS SOFA	176	594	609	624	120x190 H12	/
2 PLCS SOFA	156	589	604	619	100x190 H12	/
ARMCHAIR BED	126	584	599	614	70x190 H12	/
LOUNGE CHAIR (WITH CONTAINER)	68x160	424	434	444	/	/

Supplement Mattress

MATTRESS H 16 cm



MAXI SOFA	3 PLCS SOFA	2,5 PLCS SOFA	2 PLCS SOFA	ARMCHAIR
45	40	37	34	30



VERSION BED H12	WIDTH	OFFER	A	B	MEASURES MATTRESS STANDARD ELECT/F.R. 30KG	MT. FABRIC
MAXI SOFA	212	634	649	664	180x190 H12	/
3 PLCS SOFA	192	599	614	629	140x190 H12	/
2,5 PLCS SOFA	172	594	609	624	120x190 H12	/
2 PLCS SOFA	152	589	604	619	100x190 H12	/
ARMCHAIR BED	122	584	599	614	70x190 H12	/
LOUNGE CHAIR (WITH CONTAINER)	68x160	424	434	444	/	/

*CUSHIONS

All CUSHIONS are made strictly in the same fabric and color of the sofa

FABRICS COORDINATES

For sofas and armchairs made of two different fabrics you must add an additional charge of 5%



VERSION BED H12	WIDTH	OFFER	A	B	MEASURES MATTRESS STANDARD ELECT/F.R. 30KG	MT. FABRIC
MAXI SOFA	218	634	649	664	180x190 H12	/
3 PLCS SOFA	198	599	614	629	140x190 H12	/
2,5 PLCS SOFA	178	594	609	624	120x190 H12	/
2 PLCS SOFA	158	589	604	619	100x190 H12	/
ARMCHAIR BED	130	584	599	614	70x190 H12	/
LOUNGE CHAIR (WITH CONTAINER)	68x160	424	434	444	/	/

*CUSHIONS

All CUSHIONS are made strictly in the same fabric and color of the sofa

FABRICS COORDINATES

For sofas and armchairs made of two different fabrics you must add an additional charge of 5%

CUSHIONS

	SIZE	OFFER	A	B				MT. FABRIC
CUSHIONS 55x55	55x55	50	60	66				/
CUSHIONS 45x45	45x45	39	44	50				/

We also produce in the customers own materials

	MAXI	3 PLCS	2 PLCS	ARMCHAIR
Fabric needed	12	11	9	7

ATTENTION:

the prices of the mattresses, the footage of fabric and all accessories in general (except pouf) do not include shipping costs. Delivery will be free if it will happen anyway with the sofas.

SALES CONDITIONS

The colors of our samples are only indicative, since it is technically impossible to keep the colors over time.

The measures included in this list may be subject to a significant tolerance. The manufacturer reserves the right to make any changes to the products that could be necessary to the improvement of the products without prior notice.

No claims are accepted after eight days of receipt of goods.

The House Producer will repairs exclusively at it's plants, for technical and security reasons. In no case there will be presentations at homes or premises other than those mentioned above.

Withdrawals product for repair, will take place at the headquarters of the store or it's authorized warehouse loading / unloading goods. In no case any assistance will be done at different locations specified above.

The recalled product for repair will be checked by qualified technicians in charge, who will provide to determine the cause, feasibility and costs of intervention.

If the customer waives the repair, he will still reimburse costs for Valet and re-delivery of the merchandise.

GUARANTEE OF SALE

The product warranty is valid for a maximum period of 24 months from the date of product purchase. To establish the date of purchase will attest the receipt issued by the seller (signed invoice). The warranty is only valid in cases where the imperfections found on the product are clearly "defects from source" and not caused by the use.

The guarantee has not value in cases where complaints relate to the following situations:

damage caused by burns, cuts, from animals or other forms of bad treatment.
commercial, rental and other non-domestic uses.
damage due to corrosive materials, acids, solvents, dyes, inks, paints, fluids of various types.
damage due to external agents of various types.
damage due to natural disasters.
damage sustained during the management, handling, transport and installation of the product.
actions taken by the user or other persons, without consultation and approval of the manufacturer.
variations due to rubbing of rough clothes, shoes or other objects unsuitable.
misuse of the product (example: sit on the arms, come up with your feet, jump on and so on).
discoloration due to exposure to the direct sunlight, extreme heat, bright lights etc. alterations from normal wear and tear.

Once established collateral requirements, NEW CONCEPTS SRL will provide "free of charge" repair as quickly as possible.

THERE ARE NO CHANGES WITH NEW PRODUCTS.

For any dispute the jurisdiction will be BARI Court. Although not mentioned will prevail on the applicable national Italian regulations.



Official Dealer



NewTrendConcepts
— — — I T A L I A

